

C310 HD WEBCAM

Complete Setup Guide

设置指南



logitech®

CONTENTS

English3

简体中文6

繁體中文9

한국어 12

Indonesia 15

KNOW YOUR PRODUCT

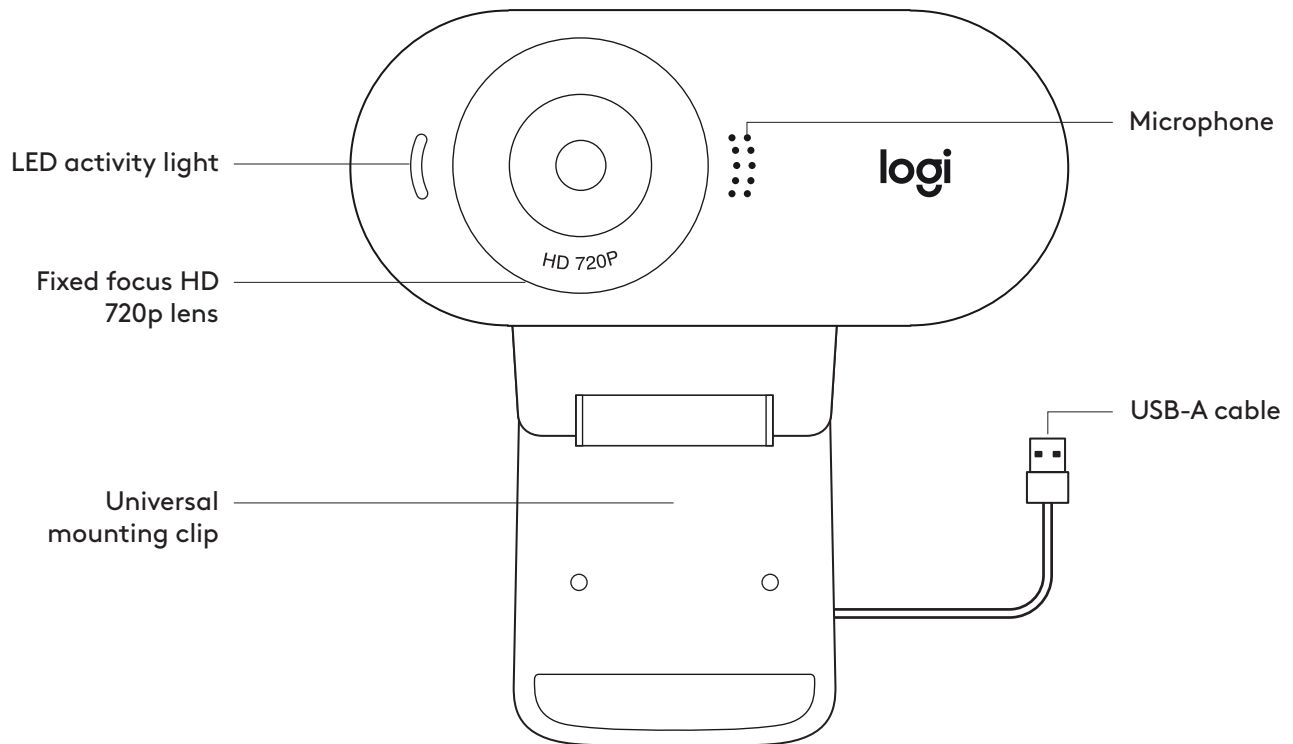

WHAT'S IN THE BOX

- 1 Webcam with 5 ft (1.5 m) attached USB-A cable
- 2 User documentation

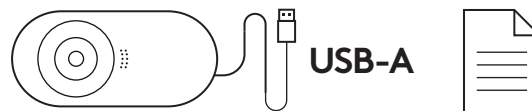

SETTING UP THE WEBCAM

1 Place your webcam on a computer, laptop or monitor at a position or angle you desire.

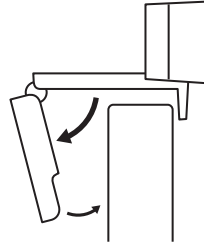

2 Adjust the webcam to make sure the end on the universal mounting clip is flush with the back of your device.

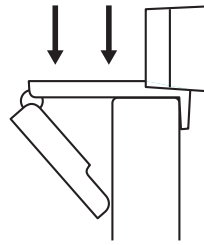

3 Manually adjust the webcam up/down to the best position to frame yourself.

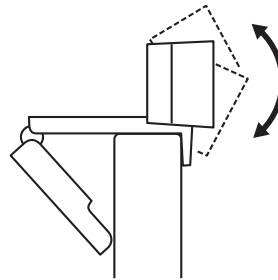

CONNECTING THE WEBCAM VIA USB-A

Plug the USB-A connector into the USB-A port on your computer.

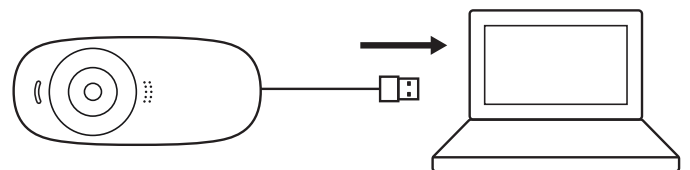

SUCCESSFUL CONNECTION

LED activity light will light up when the webcam is in use by an application.

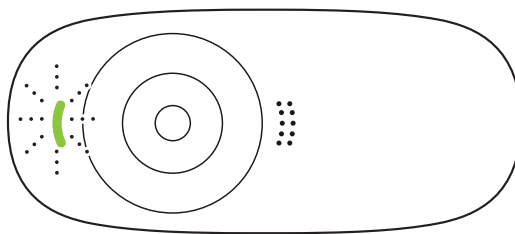

DIMENSIONS

INCLUDING FIXED MOUNTING CLIP:

Height x Width x Depth:

2.80 in (71.15 mm) x 1.23 in (31.3 mm) x 1.02 in (25.95 mm)

Cable Length: 5 ft (1.5 m)

Weight: 2.51 oz (71.2 g), including clip and cable

www.logitech.com/support/C310

了解您的产品

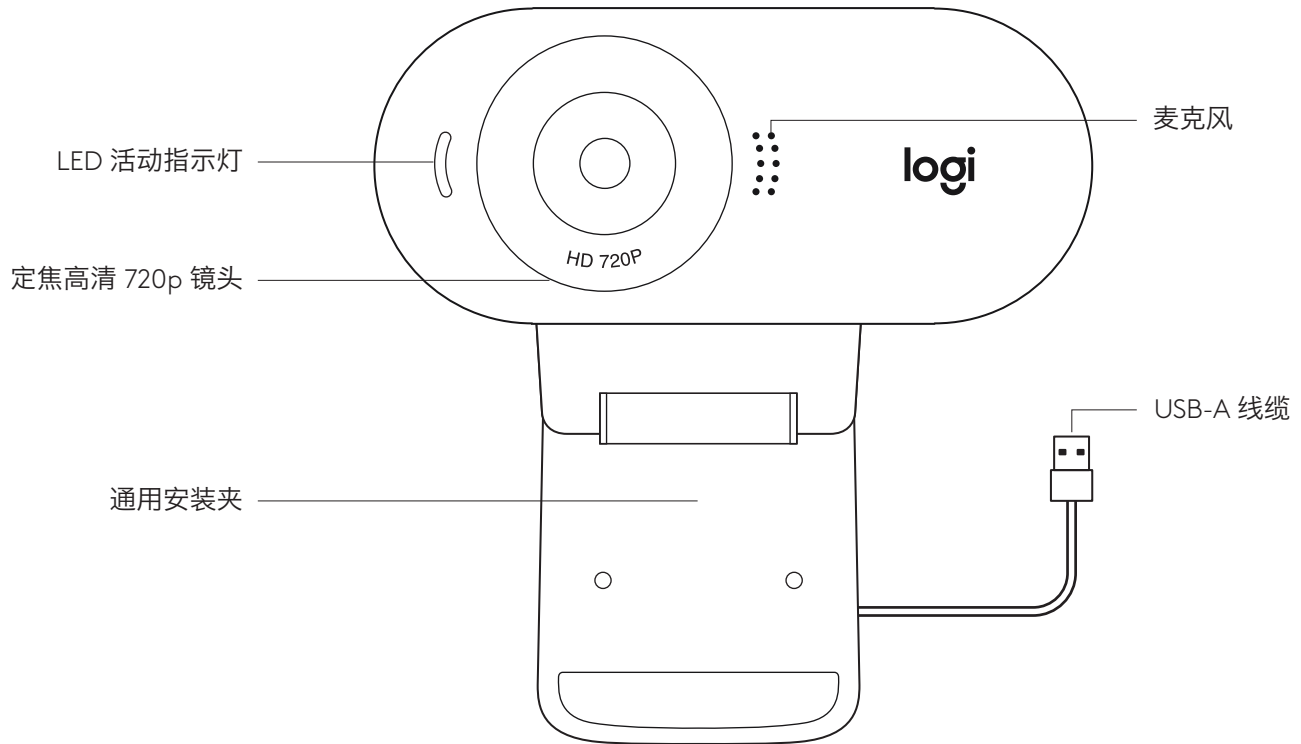

包装内容

- 1 网络摄像头，附约 1.5 米 USB-A 线缆
- 2 用户文档

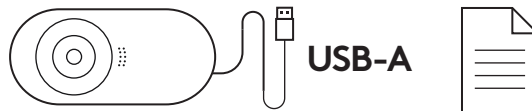

设置网络摄像头

1 将网络摄像头以所需的位置或角度放置在电脑、笔记本电脑或显示器上。

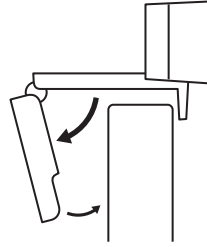

2 调节网络摄像头，确保通用安装夹底端与显示器背面齐平。

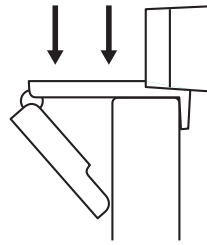

3 手动将网络摄像头上/下调节至合适的构图位置。

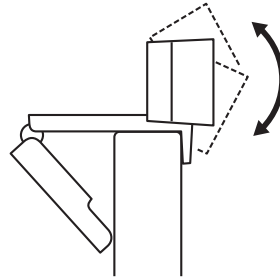

通过 USB-A 连接网络摄像头

将 USB-A 接头插入电脑的 USB-A 端口。

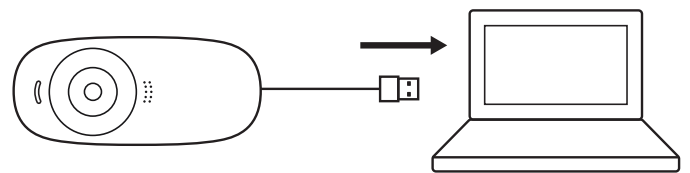

成功连接

当应用程序使用网络摄像头时，LED 活动指示灯将点亮。

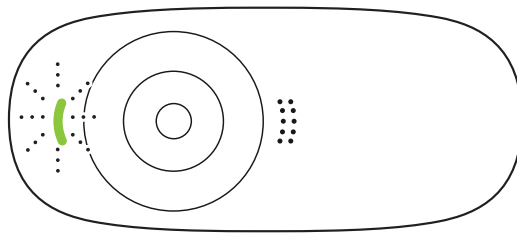

规格

包括固定的安装夹:

高 x 宽 x 深:

约 71.15 毫米 x 约 31.3 毫米 x 约 25.95 毫米

线缆长度: 约 1.5 米

重量: 约 71.2 克 (含安装夹和线缆)

www.logitech.com/support/C310

瞭解您的產品

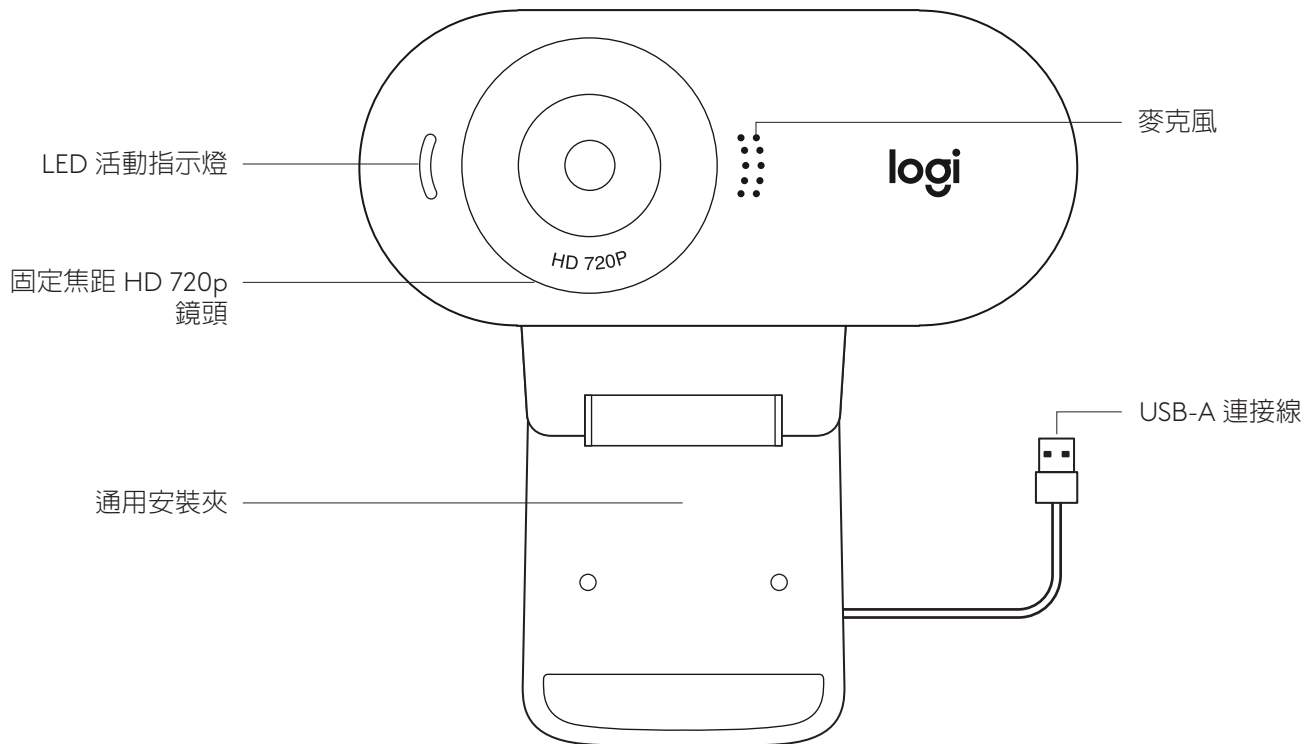

包裝內容

- 1 含 1.5 公尺 (5 英尺) USB-A 連接線的網路攝影機
- 2 使用者文件

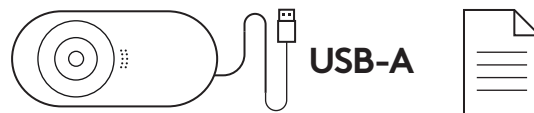

設定網路攝影機

1 將網路攝影機放到電腦、筆記型電腦或顯示器上您要的位置或角度。

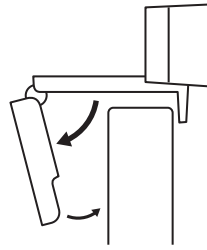

2 調整網路攝影機，確認通用安裝夾的末端與您的裝置背面齊平。

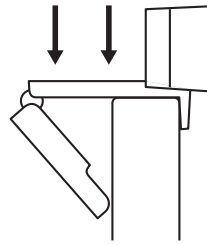

3 手動上/下調整網路攝影機，將其調整到對準您取景的最佳位置。

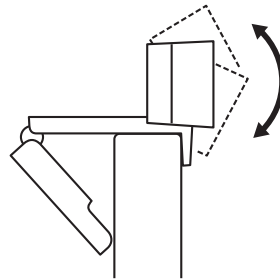

透過 USB-A 連接網路攝影機

將 USB-A 接頭插入您電腦的 USB-A 連接埠。

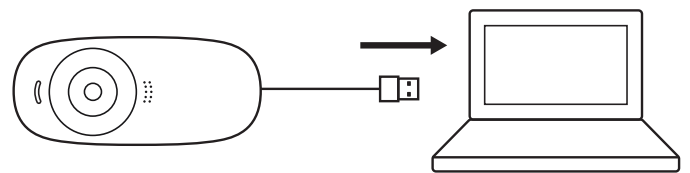

成功連接

LED 活動指示燈會在應用程式使用網路攝影機時亮起。

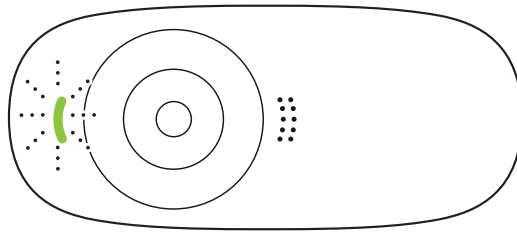

尺寸

包含固定安裝夾：

高 x 寬 x 深：

71.15 公釐 (2.80 英吋) x 31.3 公釐 (1.23 英吋) x 25.95 公釐
(1.02 英吋)

連接線長度：1.5 公尺 (5 英尺)

重量：71.2 公克 (2.51 盎司)，含夾具與連接線

www.logitech.com/support/C310

제품 설명

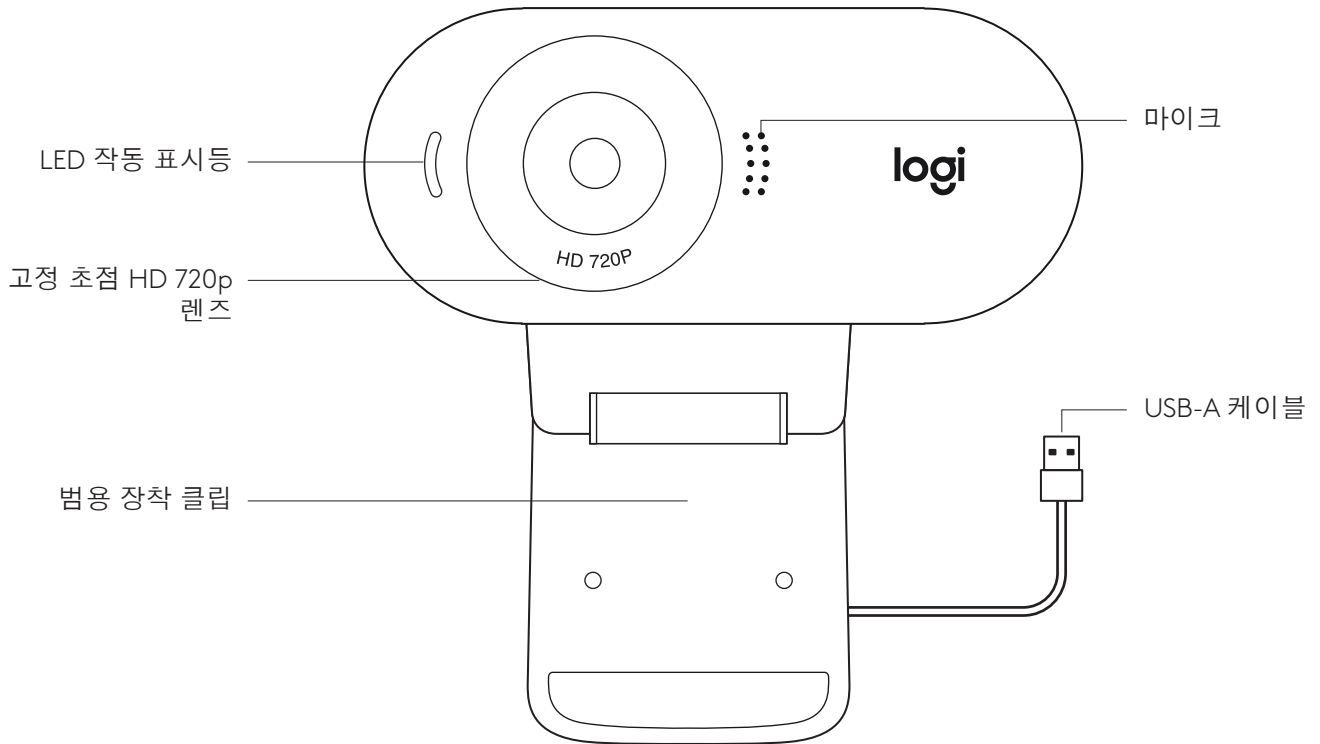

박스 내용물

1. 1.5m (5피트) USB-A 케이블이 부착된 웹캠
2. 사용 설명서

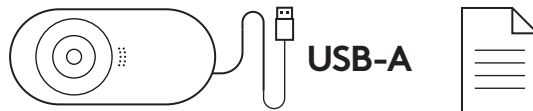

웹캠 설정

1 컴퓨터 위, 노트북, 모니터 등 원하는 위치 및 각도에 웹캠을 거치합니다.

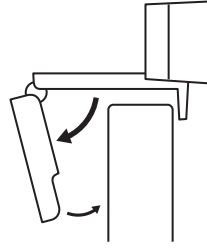

2 웹캠을 조절하여 거치할 장치의 후면과 범용 장착 클립의 끝이 평행을 이루게 합니다.

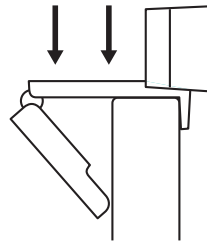

3 웹캠을 위아래로 조절하여 최적의 촬영 위치를 찾습니다.

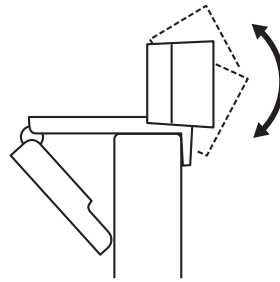

USB-A로 웹캠 연결

USB-A 커넥터를 컴퓨터 USB-A 포트에 연결합니다.

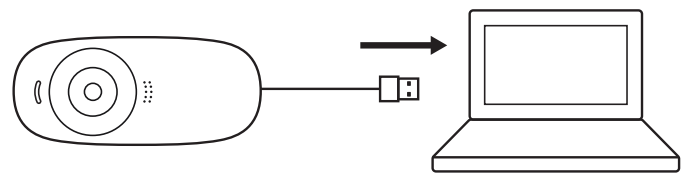

연결 성공

애플리케이션에서 웹캠을 사용하면 LED 작동 표시등에 불이 들어옵니다.

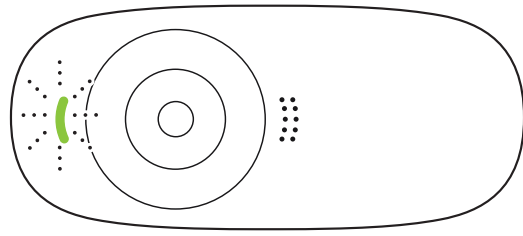

규격

고정 장착 클립 포함

높이 x 너비 x 높이:

71.15mm(2.80인치) x 31.3mm(1.23인치) x 25.95mm
(1.02인치)

케이블 길이: 1.5미터 (5피트)

무게: 71.2g(2.51oz) (클립 및 케이블 포함)

www.logitech.com/support/C310

MENGENAL PRODUK

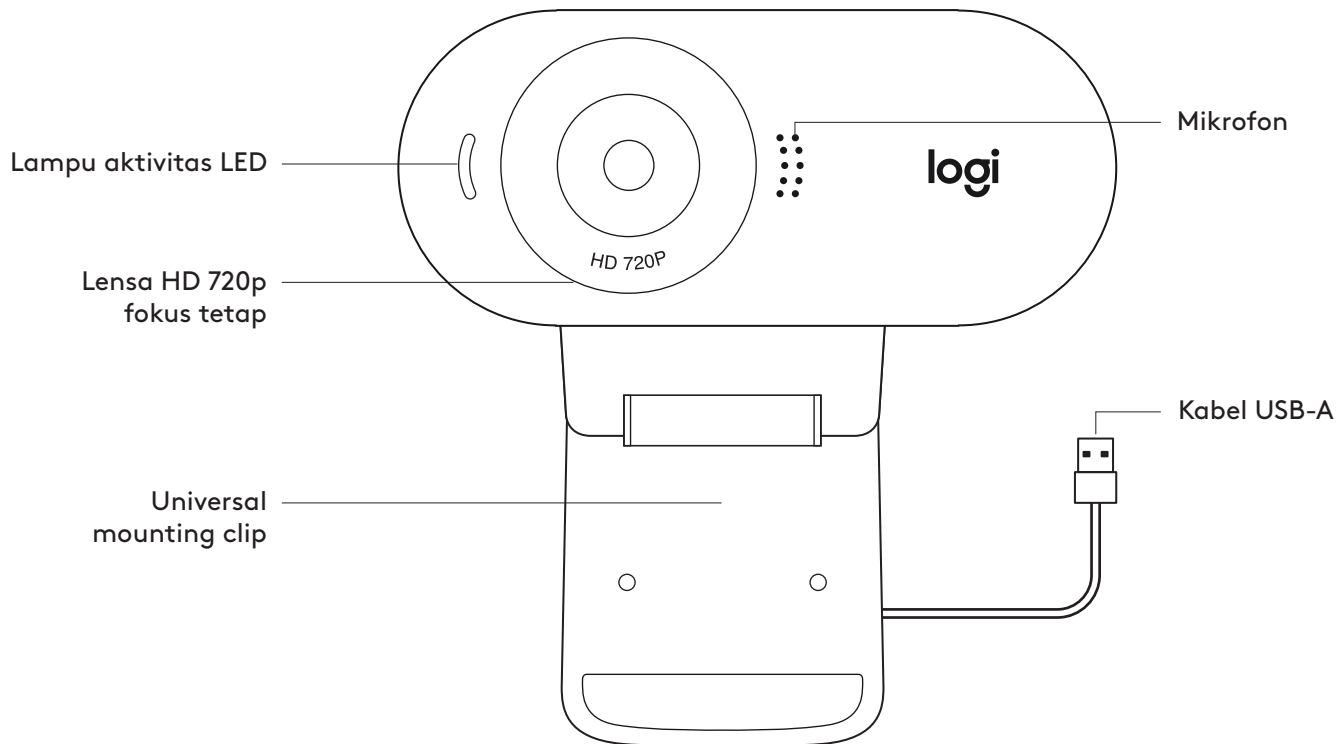

ISI KEMASAN

- 1 Webcam dengan kabel USB-A 5 kaki (1,5 m) terpasang
- 2 Dokumentasi pengguna

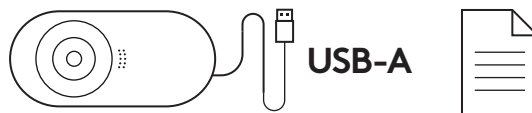

MEMASANG WEBCAM

1 Letakkan webcam Anda di komputer, laptop, atau layar pada posisi atau sudut yang Anda inginkan.

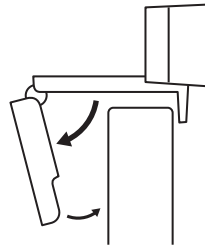

2 Sesuaikan webcam untuk memastikan ujung universal mounting clip terpasang erat dengan bagian belakang perangkat Anda.

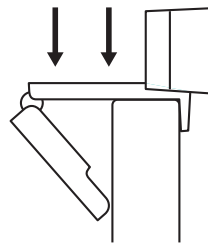

3 Gerakkan webcam ke atas/ke bawah ke posisi terbaik agar bisa menangkap diri Anda.

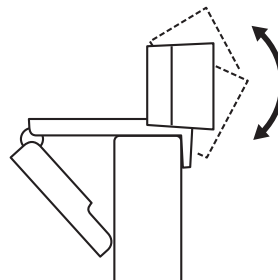

MENGHUBUNGKAN WEBCAM VIA USB-A

Pasangkan konektor USB-A ke port USB-A di komputer Anda.

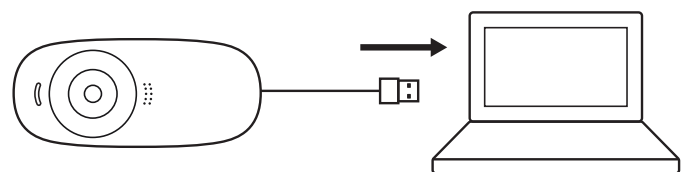

KONEKSI BERHASIL

Lampu aktivitas LED akan menyala ketika webcam digunakan oleh sebuah aplikasi.

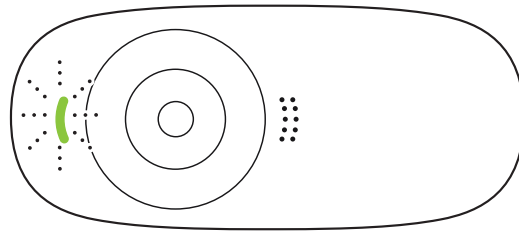

DIMENSI

TERMASUK FIXED MOUNTING CLIP:

Tinggi x Lebar x Tebal:

2,80 inci (71,15 mm) x 1,23 inci (31,3 mm) x 1,02 inci
(25,95 mm)

Panjang Kabel: 5 kaki (1,5 inci)

Berat: 2,51 oz (71,2 g), berat termasuk klip dan kabel

www.logitech.com/support/C310